

EXTERIOR

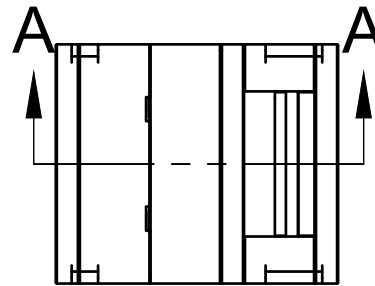

CAVITY

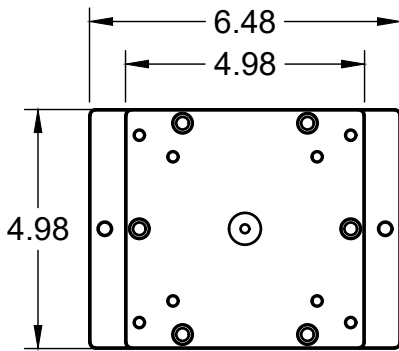
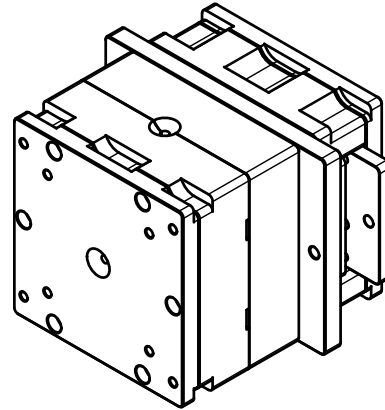
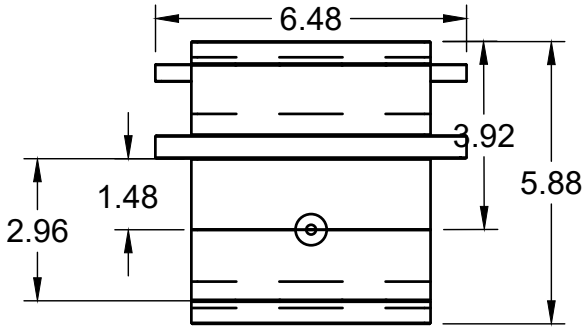
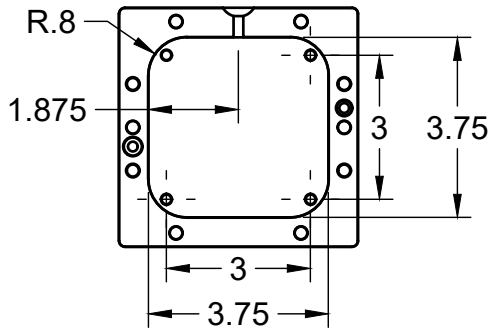

SECTION A-A

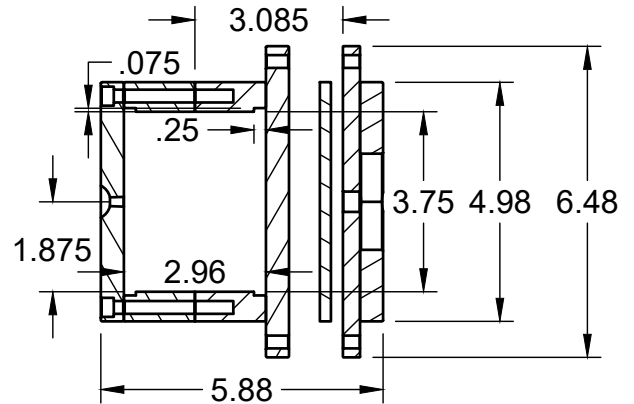

All dimensions are in inches

PROJECT

Mold Frame MFC505040EW

TITLE

**Mold Frame 5x5x4 Assembly
with Wide Ejector**

APPROVED

SIZE

CODE

DWG NO

REV

CHECKED

A

DRAWN

4/3/2023

SCALE 1:4

WEIGHT

SHEET 3/4