

EXTERIOR

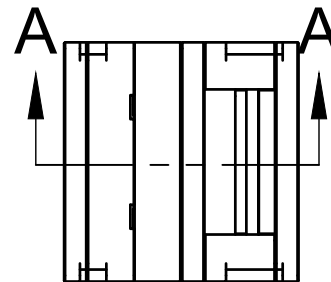

CAVITY

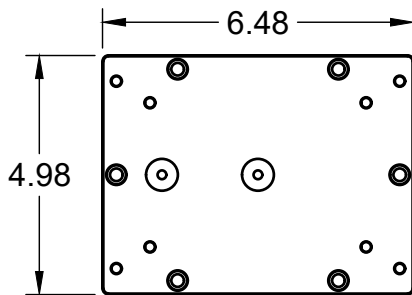
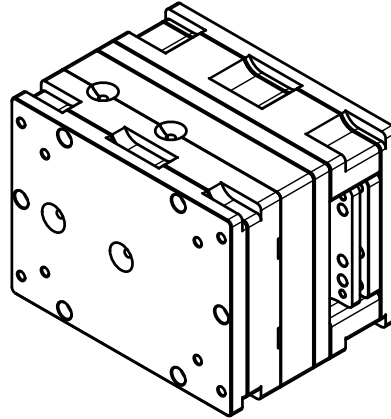
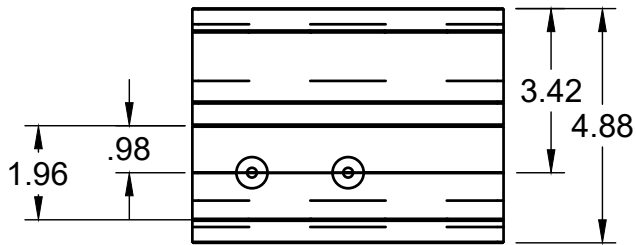
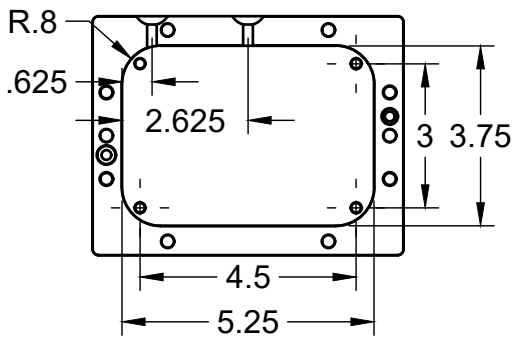

SECTION A-A

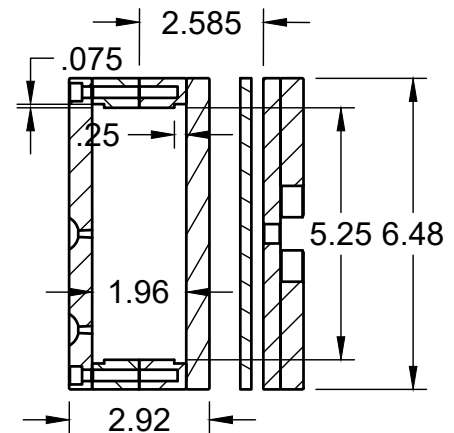

All dimensions are in inches

PROJECT

Mold Frame MFC655030ES

TITLE

**Mold Frame 6.5x5x3 Assembly
with Standard Width Ejector**

APPROVED

SIZE

CODE

DWG NO

REV

CHECKED

A

DRAWN

4/3/2023

SCALE 1:4

WEIGHT

SHEET 2/4