

EXTERIOR

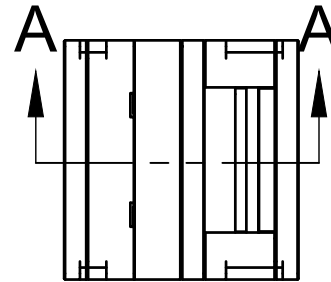

CAVITY

SECTION A-A

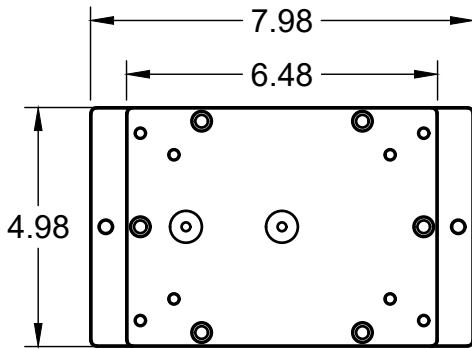
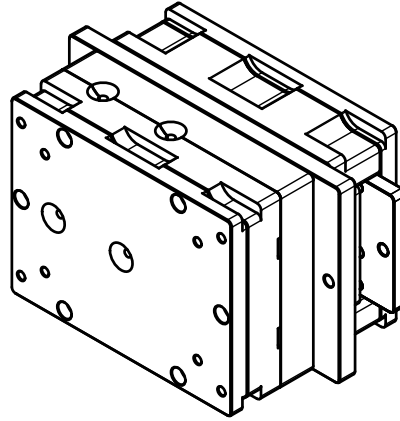
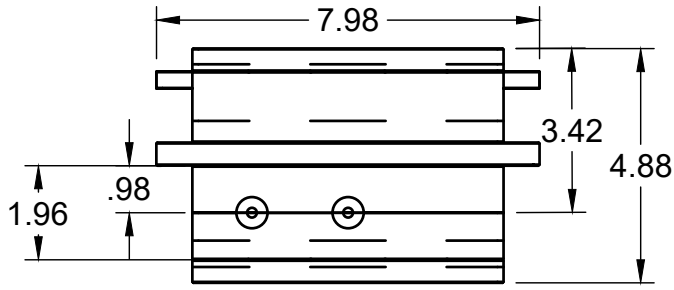
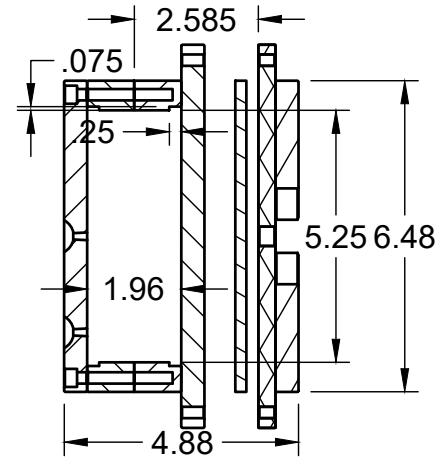
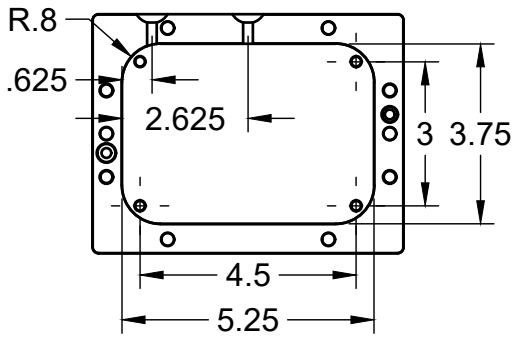

All dimensions are in inches

PROJECT

Mold Frame MFC655030EW

TITLE

**Mold Frame 6.5x5x3 Assembly
with Wide Ejector**

APPROVED

SIZE

CODE

DWG NO

REV

CHECKED

A

DRAWN

4/3/2023

SCALE 1:4

WEIGHT

SHEET 3/4